



Commercial  
Vehicles



**The Amarok**

**Uncompromising off-road. Spirited on the asphalt**  
The Amarok combines everything that you expect from an exclusive, premium, class leading vehicle.

### **Unique drive combination**

The enhanced grip of the Permanent 4x4 (4MOTION) system paired with an 8-speed automatic gearbox. Selectable 4X4 system with high and low range available with variants fitted with the 6 speed manual gearbox

### **Powerful Diesel engines**

Choice of three engines - a responsive 2.0L 4-cylinder engine with 132kW of power and up to 420Nm of torque (400Nm for manual transmission) and two V6 3.0L engines - 165kW with 550Nm of torque (500Nm for manual transmission) or 190kW and 580Nm of torque

### **Overboost**

Unique to Amarok V6 models you can have more overtaking power on tap with a quick burst delivering up to 180kW for TDI500 and TDI550 variants or 200kW for TDI580

### **Striking exterior design**

An aggressive exterior look, combined with alloy wheels, makes the Amarok range everything you expect from a premium, class leading vehicle

### **Modern interior design**

Redesigned dash panel, including air-vents and upper dash storage space

### **Advanced infotainment systems**

New audio and navigation system, along with App-Connect™ and voice recognition

### **Multi-Collision Braking System\***

This new system triggers braking post collision to help prevent secondary collisions

### **Largest tray in its class**

With a load area over 2.5m<sup>2</sup> in area and able to fit a pallet between the wheel arches

### **Stopping Power**

Unique to the Amarok V6 models are 332mm disc brakes up front and 300mm disc brakes in the rear

### **High level of grip on every terrain**

Outstanding off-road ABS and Hill Descent Assist

# Pretty



~App-Connect is compatible for selected apps with the latest smartphone versions of iOS and Android, active data service, and connection cable (sold separately).

\*Safety technologies are designed to assist the driver, but should not be used as a substitute for safe driving practices.

# y, Rugged



# Amarok V6 Range

## Standard equipment Amarok Core 4x4

### Exterior

- 16-inch 'Korama' alloy wheels
- Halogen headlights with LED daytime running lights
- Park distance control rear with reverse camera
- Black rear bumper with step

### Interior

- Austin cloth seat upholstery
- Instrument cluster with multi-function Plus display
- Leather-covered multi-function steering wheel
- Cruise control
- Single zone air conditioning system
- Composition Media audio system
- App-Connect™ USB interface
- Rear parking sensors with Rear View Camera\*
- Multi-Collision Braking system\*

## Standard equipment Amarok Core V6

### Exterior

- 17-inch Posadas alloy wheels
- Radiator grille with chrome element
- Extended wheel arches
- Front fog lights

### Interior

- Austin cloth seat upholstery
- Instrument cluster with multi-function Plus display
- Leather-covered multi-function steering wheel
- Cruise control
- Single zone air conditioning system
- Composition Media audio system
- App-Connect™ USB interface
- Rear parking sensors with Rear View Camera\*
- Multi-Collision Braking system\*

## Standard equipment Amarok Sportline V6

### Core V6, plus:

### Exterior

- 18-inch Manaus alloy wheels
- Radiator grille with chrome elements
- Comfort closing lockable rear tailgate
- Colour-coated exterior mirrors, partially chromed
- Rear privacy glass
- Rear bumper, chromed, with integrated step
- Tinted tail lights

### Interior

- Salipra cloth seat upholstery
- Dash panel with decorative inserts in bright silver
- Dual-zone Climatronic air conditioning system
- Four 12V sockets, (three in cabin and one in tray)
- Front and rear parking sensors with Rear View Camera\*



~App-Connect is compatible for selected apps with the latest smartphone versions of iOS and Android, active data service, and connection cable (sold separately).

\*Safety technologies are designed to assist the driver, but should not be used as a substitute for safe driving practices.

## Standard Equipment Amarok Highline V6 TDI580

Sportline V6, plus:

### Exterior

- 18-inch Rawson alloy wheels
- Bi-xenon headlights with LED daytime running lights
- Stainless steel styling bar
- Stainless steel side steps
- Front fog lights with cornering function

### Interior

- Discover Media navigation system
- Alarm with interior monitoring
- Safelock (deadlocking) system

## Standard equipment Amarok Aventura V6 TDI580

Highline V6 580, plus:

### Exterior

- Silver 20-inch Talca alloy wheels
- Moulded styling bar (body coloured)
- Stainless steel side steps with illumination
- Special cargo area coating

### Interior

- Nappa leather appointed upholstery<sup>#</sup> in black
- ergoComfort seats for driver and front passenger (14-way electric, 2-way manual)
- Instrument cluster with Premium Colour multi-function display
- Leather-covered multi-function steering wheel with paddle shifters
- Stainless steel pedals
- Tailored carpet mats



<sup>#</sup>Leather appointed seats have a combination of genuine and artificial leather, but are not wholly leather.

# When Power Is Everything

## The legendary Volkswagen 2.0L TDI engine The 2.0L TDI 4-cylinder engine

With up to 132kW of power and 420Nm of torque, the 2.0 TDI has proven itself as worksite and bush trail ready. With not one but two turbo-chargers, this Bi-turbo unit delivers power and torque from super low revs ensuring a smoother and more enjoyable driving experience.

### **2.0L TDI400 (132kW, 400Nm)**

Fuel consumption 8.4L / 100km\*\*

CO<sub>2</sub> emissions: 220 g/km

### **2.0L TDI420 (132kW, 420Nm)**

Fuel consumption 8.9L / 100km\*\*

CO<sub>2</sub> emissions: 234 g/km

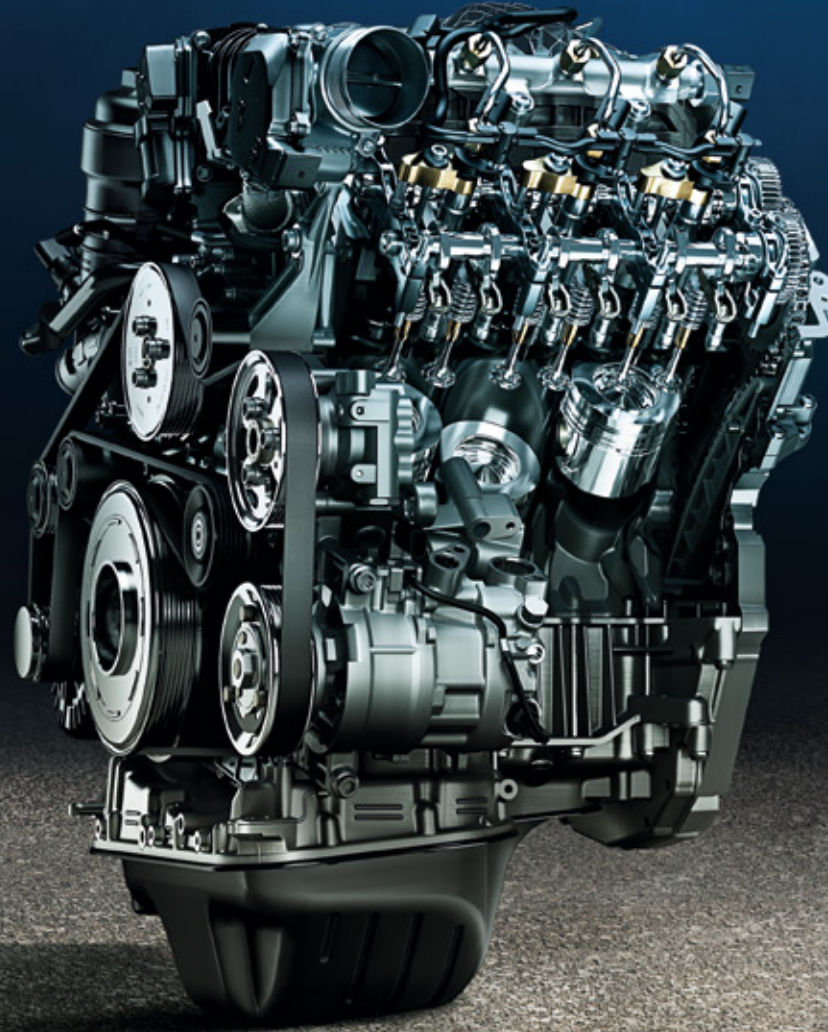

### **3.0L TDI500 (165kW, 500Nm) Overboost function up to 180kW**

Fuel consumption: 9.7L / 100km\*\*

CO<sub>2</sub> emissions: 254 g/km

### **3.0L TDI550 (165kW, 550Nm) overboost function up to 180kW**

Fuel consumption: 9.1L / 100km\*\*

CO<sub>2</sub> emissions: 240 g/km

### **3.0L TDI580 (190kW, 580Nm) overboost function up to 200kW**

Fuel consumption 9.5L / 100km\*\*

CO<sub>2</sub> emissions: 250 g/km

\*\*Fuel consumption figures according to Australian Design Rule (ADR) 81/02 derived from laboratory testing. Factors including but not limited to driving style, road and traffic conditions, environmental influences, vehicle condition and accessories fitted, will in practice in the real world lead to figures which generally differ from those advertised. Advertised figures are meant for comparison amongst vehicles only.

# ng V6

## Powerful like no other The V6 3.0L TDI engine

Available in three power outputs producing 165kW and 550Nm of torque (500Nm for manual transmissions) or 190kW and 580Nm of torque. The V6 turbodiesel engine has more than enough power reserves even in the most demanding situations. With Overboost, you can ramp up the power even more when you need it most with a quick burst of either up to 180kW or 200kW, depending on your engine, while also prolonging maximum torque delivery. Optimised in 3rd and 4th gear, the Overboost function increases the engine's output for up to ten seconds, making it ideal for overtaking.



**01 Permanent 4x4.** This always-on 4x4 system with Torsen differential excels on all surfaces. Torque is mechanically distributed from front to rear (40:60) with the ability to drive distribution to each wheel optimised by traction control intervention (available with automatic transmission only).

**02 Selectable 4x4.** The 4x4 drive system with a transfer case enables the front wheels to be electrically engaged and disengaged while driving. On steep inclines or longer stretches of challenging terrain an additional reduction gear set can also be engaged (available with manual transmission only).



**03 8-speed automatic gearbox.** The Amarok is the only vehicle in its class that offers the flexibility and performance of the 8-speed automatic transmission. The 1st gear is designed for off-road driving, whereas the 8th gear is optimised for economy driving at highway speeds.

**04 6-speed manual gearbox and Selectable 4x4 4MOTION (not illustrated).** The robust 6-speed manual gearbox offers responsive and smooth gear changes for all driving conditions. The manual transmission is combined with the dual range Selectable 4x4 system (available on Core models only).

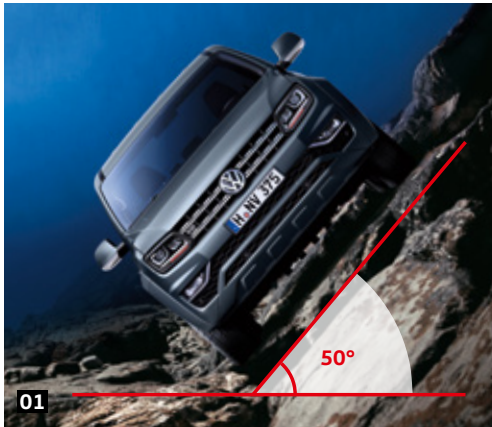

**01 Side slope angle.** The broad track of the Amarok provides enormous stability even when driving along slopes with up to a 50° incline.<sup>1</sup>

**02 High-climbing ability.** The Amarok handles 100% (45°) grades with up to maximum payload.<sup>1</sup>

**03 Off-road ABS.** Once activated, the wheels lock when braking on loose surfaces with a larger interval, essentially creating a wedge which significantly reduces the braking distance. This noticeably increases the driving safety.

**04 Approach/departure angle and wading depth.** The maximum slope angle for the Amarok is 28.0° at the front and 23.6° at the rear. It can handle pools with a wading depth of 500 mm.

# King

100% incline, 50° gradient  
and off-road ABS  
**Outstanding all terrain  
performance**

Asphalt, dirt, gravel. In the Amarok you will experience the ultimate in driving capability on almost any terrain. It combines high ground clearance with rigid body stability along with the proven 4MOTION all-wheel drive system. This vehicle also comes into its own on the road, with the Torsen® differential significantly increasing traction while cornering.



<sup>1</sup> Figures may vary depending on the equipment line and engine type. Please note that these are statically calculated figures.



# Of The Hill



Highline model shown



### **Premium equipment**

The only vehicle in its class with ergoComfort seats

The Amarok Aventura (shown) offers a premium leather appointed upholstery seats# with additional under-seat storage, rear grab handles and individual map lamps. In addition, the Amarok Aventura offers a leather-wrapped multi-function steering wheel with shift paddles as well as front 14-way adjustable ergoComfort seats.

# Leather appointed seats have a combination of genuine and artificial leather, but are not wholly leather.



**01 Composition Media system**

The crystal clear 6.33" colour touch screen is packed with the latest multimedia functions, including App-Connect™ and Bluetooth®. For added convenience the telephone functions can be voice activated.

| CE | CE6 | SL |



**02 App-Connect™**

With this function, selected apps are mirrored from your smart phone to the touch screen of the radio or navigation system display via the USB port and controlled using the touchscreen.

| CE | CE6 | SL | HL | AV |



**03 Discover Media navigation system.**

In addition to the functions of the Composition Media radio system with six loud speakers, there is a second integrated SD-card slot which is compatible with the SD-card with the map data.

| HL | AV |



**04 Voice Control.**

You are free to operate the telephone and audio functions without taking your hands off the steering wheel. Furthermore, you can call up virtually all menus and notifications on the radio using voice control.

| CE | CE | CE6 | SL | HL | AV |



**05 Climatronic air conditioning.** This system offers 2-zone temperature control for the driver and front passenger. Depending on the intensity of the sun's rays and the outside temperature, the air conditioning adds more or less cool air accordingly.

| SL | HL | AV |

\*App-Connect is compatible for selected apps with the latest smartphone versions of iOS and Android, active data service, and connection cable (sold separately).



01

**01 Cargo area coating.** The UV-resistant special coating in anthracite provides excellent protection against mechanical and chemical wear. | AV |



02

**02 Load light.** The exterior load light helps illuminate the tray, ideal for early starts or late finishes. | CE | CE6 | SL |

**The smoothest moving tailgate.** The comfort feature makes opening and closing the tailgate a breeze, while still rated to carry up to 200kg. | SL | HL | AV |

**12V socket** (not illustrated). A 12V socket is fitted on the inside of the left side panel. | SL | HL | AV |

## Packs a pallet

### The widest tray in its class

No other pickup provides so much space between the wheel arches: the loading width of 1,222 mm even enables Euro pallets to be loaded crosswise. The spacious cargo box with a 2.52 m<sup>2</sup> load surface features convincing dimensions – such as the 508 mm high side panels and the low loading sill height of 780 mm.



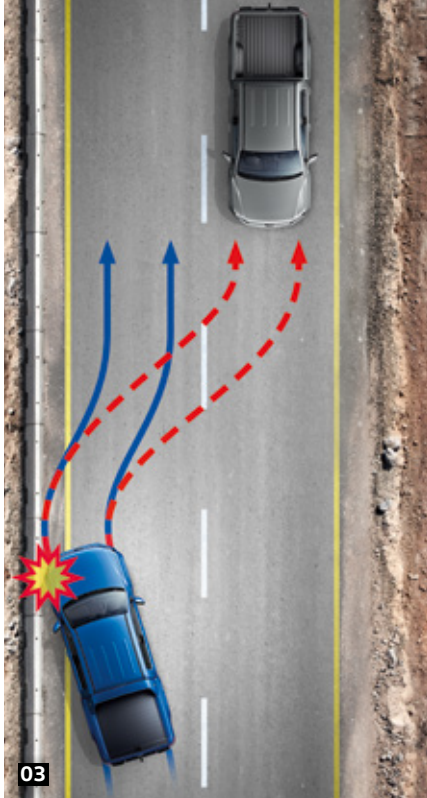

03

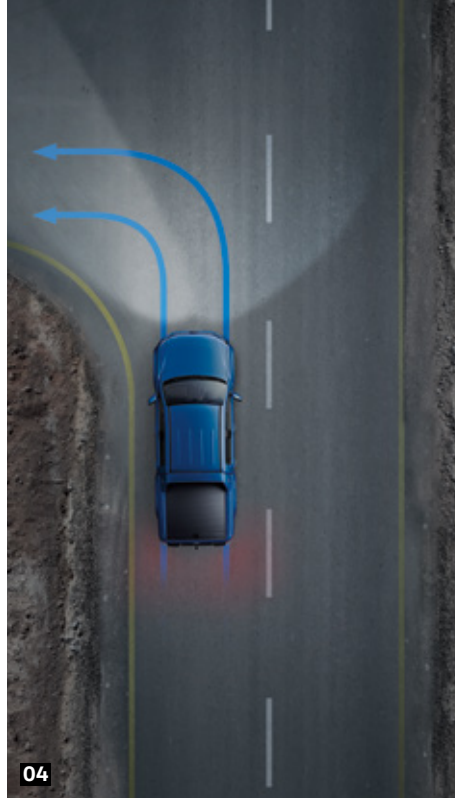



04





05

## Safety systems\*

 **03 Automatic Post-Collision Braking System.** Triggers braking after a collision, with the aim of preventing secondary collisions. After a short delay, the vehicle begins phased braking action down to 10 km/h. | CE | CE6 | SL | HL | AV |

 **Electronic Stability Programme** (not illustrated). Prevents under or over-steering via targeted braking of individual wheels. | CE | CE6 | SL | HL | AV |

 **Front and head/thorax airbags** (not illustrated) for the driver and front passenger. | CE | CE6 | SL | HL | AV |

 **Height-adjustable head restraints** (not illustrated) and 3-point seatbelts are featured throughout, with pretensioners on the front seats. | CE | CE6 | SL | HL | AV |

**332mm disc brakes in the front, 300mm disc brakes in the rear** (not illustrated). Offer an optimum performance during high brake loads. | CE6 | SL | HL | AV |

**Trailer Stabilisation** (not illustrated). Configured for the Genuine Volkswagen tow bar wiring to compliment the Electronic Stability Programme, helping to reduce trailer sway. | CE | CE6 | SL | HL | AV |

## Driver assistance systems\*

 **04 Static cornering light.** Ensures optimal visibility in poor weather conditions. The fog light nearest to the corner illuminates the roadside when turning. | HL | AV |

 **05 Rear View Camera.** Simplifies reversing by showing a limited view of the area behind the vehicle on the display. Static guidelines facilitate the parking process. | CE | CE6 | SL | HL | AV |

**Hill Start Assist** (not illustrated). Prevents the vehicle from rolling back on inclines and makes it easier to start off on uphill slopes. | CE | CE6 | SL | HL | AV |

 **Hill Descent Assist** (not illustrated). Allows you to drive down slopes in a safe, controlled way by governing the engine speed and applying the brakes, if necessary. | CE | CE6 | SL | HL | AV |

 **Park Pilot** (not illustrated). Emits audible warnings when obstacles are detected behind the vehicle when parking. | CE | CE6 | Emits audible warnings at the front and rear of the vehicle when parking. | SL | HL | AV |

 **Cruise control** (not illustrated). As of a speed of 30 km/h, it maintains the set speed depending on uphill and downhill inclines. | CE | CE6 | SL | HL | AV |

 **Tyre Pressure Monitoring System** (not illustrated). Warns when there is a deviation in tyre pressure and indicates the driver to check tyre pressure as soon as possible. | HL | AV |

 **Mechanical rear differential lock** (not illustrated). When activated ensures both rear wheels receive the same amount of power and rotations. This offers optimal traction on sandy or slippery surfaces. | CE | CE6 | SL | HL | AV |

# Tough Not

Sporty and distinctive  
**Create a strong impression**

With its stainless steel styling bar and side steps, striking front design and 18-inch Rawson alloy wheels, the Amarok Highline model creates a strong impression.

The frontal design features two double chrome strips, honeycomb grille highlights and a more aggressive fog light design.



# V6

# Rough



Highline model shown

# Technical Specifications - 4 Cylinder Range

| Engine                          | TDI400 4x4  | TDI420 4x4               |
|---------------------------------|---|--------------------------|
| Type                            | 4 cylinder Bi-turbo diesel, DOHC, 16 valve  |                          |
| Cubic capacity, litres/cc       | 2.0 / 1,968   |                          |
| Max power, kW @ rpm             | 132 @ 4,000   | 132 @ 4,000              |
| Max torque, Nm @ rpm            | 400 @ 1,500 - 2,250   | 420 @ 1,750              |
| Compression ratio               | 16.01:1   |                          |
| Fuel system                     | Common Rail Direct Injection  |                          |
| Exhaust emission control        | Water-cooled exhaust gas recirculation (EGR), catalytic converter and diesel particulate filter (DPF) |                          |
| Fuel type (Recommended)         | Diesel EN 590   |                          |
| <b>Transmission</b>             | <b>6 Speed Manual</b>   | <b>8 Speed Automatic</b> |
| Driven wheels                   | 4x4 (4MOTION) Selectable  | 4x4 (4MOTION) Permanent  |
| Gear Ratios                     | Final Drive: 4.10   | Final Drive: 3.70        |
|                                 | 1st Gear: 3.583   | 1st Gear: 4.714          |
|                                 | 2nd Gear: 1.889   | 2nd Gear: 3.143          |
|                                 | 3rd Gear: 1.114   | 3rd Gear: 2.106          |
|                                 | 4th Gear: 1.00  | 4th Gear: 1.667          |
|                                 | 5th Gear: 0.564   | 5th Gear: 1.285          |
|                                 | 6th Gear: 0.473   | 6th Gear: 1.00           |
|                                 |   | 7th Gear: 0.839          |
|                                 |   | 8th Gear: 0.667          |
|                                 | Reverse Gear: 3.250   | Reverse Gear: 3.300      |
| <b>Fuel consumption**</b>       |   |                          |
| Combined, L/100km               | 8.4   | 8.9                      |
| Urban, L/100km                  | 10.1  | 11.0                     |
| Extra Urban, L/100km            | 7.4   | 7.7                      |
| CO <sub>2</sub> emissions, g/km | 220   | 234                      |
| Fuel tank capacity, litres      | 80  | 80                       |
| <b>Towbar Capacity*</b>         |   |                          |
| Braked, kg                      | 3000  |                          |
| Unbraked, kg                    | 750   |                          |
| Towball load limit, kg          | 300   |                          |

\*\*Fuel consumption figures according to Australian Design Rules (ADR) 81/02 derived from laboratory testing. Factors including but not limited to driving style, road and traffic conditions, environmental influences, vehicle condition and accessories fitted, will in practice in the real world lead to figures which generally differ from those advertised. Advertised figures are meant for comparison amongst vehicles only.

\*When fitted with Volkswagen Genuine Tow Bar. Towing capacities are applicable to Volkswagen Genuine Accessory Tow Bar. Towing capacity figures are maximum figures and actual towing capacity depends on factors including the laden mass of the vehicle, driving conditions and fitment of any accessories. Volkswagen Group Australia does not endorse or will not be held liable for any claim, loss or damage arising from the use or fitment of electronic trailer brakes.



# Technical Specifications - 4 Cylinder Range

## Running Gear

|                   |   |
|-------------------|---|
| Suspension        | 2.0 litre, 4 cylinder TDI   |
| Front axle        | Transverse link with A-frame arm double wishbone and anti-roll bar  |
| Rear axle         | Multi-layer rigid axle with leaf spring and stabiliser bar  |
| Steering          | Power assisted rack & pinion steering   |
| Brake systems     | Anti-lock Braking System (ABS) with Electronic Brake-pressure Distribution (EBD), Brake Assist and Electronic Stabilisation Program (ESP) |
| Brakes            |   |
| Front / Rear, mm  | 303, Ventilated Discs / 295, Drum   |
| Brake systems     | ESP, off-road ABS, ASR, EDL, Hill Holder, Brake Assist, Traction Control and Off-Road ABS including Hill Descent                          |
| Turning circle, m | 12.95   |

## Weights

|                              | TDI400 4x4 Core | TDI420 4x4 Core |
|------------------------------|-----------------|-----------------|
| Unladen Mass, kg             | 2,007           | 2,022           |
| Payload, kg                  | 1,033           | 1,018           |
| Gross Vehicle Mass (GVM) kg  | 3,040           | 3,040           |
| Gross Combined Mass (GCM) kg | 5,550           | 5,550           |
| Roof load, kg                | 100             | 100             |

# Dimensions

| Exterior Dimensions    | TDI400 Core 4x4 | TDI420 Core 4x4    |
|------------------------|-----------------|--------------------|
| Overall length mm      | 5,254           | 5,254              |
| Width mm               | 1,944           | 1,954              |
| Width incl. mirrors mm | 2,228           | 2,228              |
| Height mm              | 1,834           | 1,878 <sup>^</sup> |
| Wheelbase mm           | 3,095           | 3,095              |
| Ground clearance mm    | 226             | 226                |
| Entry angle            | 28.0            | 28.0               |
| Departure angle        | 23.6            | 23.6               |
| Ramp angle             | 23.0            | 23.0               |
| Wading depth, mm       | 500             | 500                |

| Tray Dimensions                  |       |
|----------------------------------|-------|
| Length, mm                       | 1,555 |
| Width, mm (Max.)                 | 1,620 |
| Width, mm (between wheel arches) | 1,222 |
| Tailgate opening, mm (Max.)      | 1,364 |
| Height (tailgate), mm            | 508   |
| Height from ground, mm           | 780   |

## Amarok Dual Cab

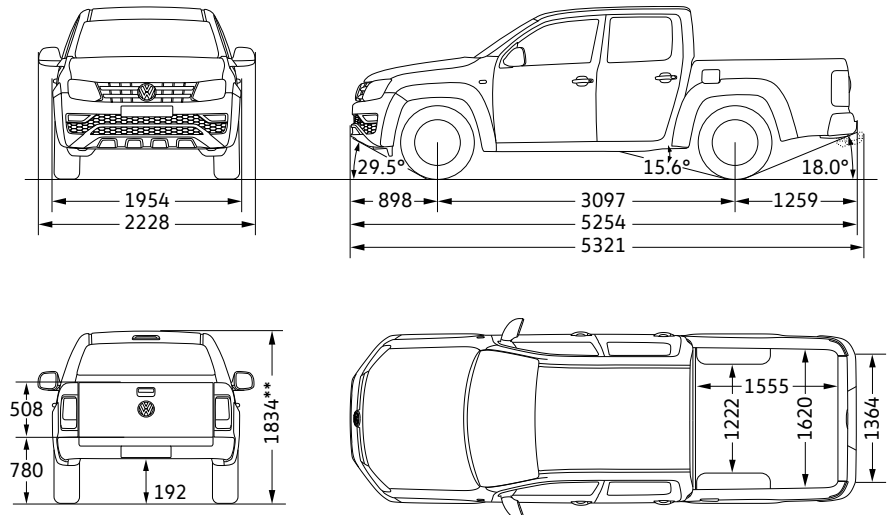

<sup>^</sup> Including sports bar

<sup>‡</sup> Payload is defined as the Gross Vehicle Mass (GVM) minus the Kerb Mass. Payload is the maximum combined weight of occupants, cargo, added structures and tow ball down weight (when towing). GVM must not be exceeded.

\*\*Height shown without sports bar.

# Technical Specifications - 6 Cylinder Range

| Engine                          | 3.0 litre V6 TDI500   | 3.0 litre V6 TDI550  | 3.0 litre V6 TDI580  |                    |                    |
|---------------------------------|---|--|--|--------------------|--------------------|
| Type                            | 6 cylinder turbo diesel, 24 valve   | 6 cylinder turbo diesel, 24 valve  | 6 cylinder turbo diesel, 24 valve  |                    |                    |
| Cubic capacity, litres/cc       | 3.0 / 2,967   | 3.0 / 2,967  | 3.0 / 2,967  |                    |                    |
| Max power, kW @ rpm             | 165 @ 3,250 - 4,500   | 165 @ 2,500 - 4,500  | 190 @ 3,250 - 4,500  |                    |                    |
| Max torque, Nm @ rpm            | 500 @ 1,250 - 3,000   | 550 @ 1,500 - 2,500  | 580 @ 1,400 - 3,000  |                    |                    |
| Compression ratio               | 17.0:1  | 17.0:1   | 17.0:1   |                    |                    |
| Fuel system                     | Bosch EDC17 electronic engine control unit  | Bosch EDC17 electronic engine control unit   | Bosch EDC17 electronic engine control unit   |                    |                    |
| Exhaust emission control        | Water-cooled exhaust gas recirculation (EGR), catalytic converter and diesel particulate filter (DPF)                                 | Water-cooled exhaust gas recirculation (EGR), catalytic converter and diesel particulate filter (DPF)  | Water-cooled exhaust gas recirculation (EGR), catalytic converter and diesel particulate filter (DPF)  |                    |                    |
| Fuel type (Recommended)         | Diesel EN 590   | Diesel EN 590  | Diesel EN 590  |                    |                    |
| <b>Transmission</b>             | <b>6 Speed Manual</b>   | <b>8 Speed Automatic</b>   | <b>8 Speed Automatic</b>   |                    |                    |
| Driven wheels                   | 4x4 (4MOTION) Selectable  | 4x4 (4MOTION) Permanent  | 4x4 (4MOTION) Permanent  |                    |                    |
| Gear Ratios                     | 1st Gear: 5.070<br>2nd Gear: 2.614<br>3rd Gear: 1.524<br>4th Gear: 1.000<br>5th Gear: 0.770<br>6th Gear: 0.657<br>Reverse Gear: 4.823 | 1st Gear: 4.714<br>2nd Gear: 3.143<br>3rd Gear: 2.106<br>4th Gear: 1.667<br>5th Gear: 1.285<br>6th Gear: 1.00<br>7th Gear: 0.839<br>8th Gear: 0.667<br>Reverse Gear: 3.317 | 1st Gear: 4.714<br>2nd Gear: 3.143<br>3rd Gear: 2.106<br>4th Gear: 1.667<br>5th Gear: 1.285<br>6th Gear: 1.00<br>7th Gear: 0.839<br>8th Gear: 0.667<br>Reverse Gear: 3.317 |                    |                    |
| <b>Performance#</b>             |   |  |  |                    |                    |
| 0 - 100km/h, seconds            | xx  | 7.9  |  |                    | 7.3                |
| <b>Fuel consumption**</b>       |   |  |  |                    |                    |
| Combined, L/100km               | 9.7   | 9.1  |  |                    | 9.5                |
| Urban, L/100km                  | 11.4  | 10.6   |  |                    | 11.4               |
| Extra Urban, L/100km            | 8.6   | 8.3  |  |                    | 8.4                |
| CO <sub>2</sub> emissions, g/km | 254   | 240  |  |                    | 250                |
| Fuel tank capacity, litres      | 80  | 80   |  |                    | 80                 |
| <b>Towbar Capacity#</b>         | <b>Core V6 Manual</b>   | <b>Core V6</b>   | <b>Sportline V6</b>  | <b>Highline V6</b> | <b>Aventura V6</b> |
| Braked kg                       | 3,000   | 3,500  | 3,500  | 3,500              | 3,500              |
| Unbraked, kg                    | 750   | 750  | 750  | 750                | 750                |
| Towball load limit, kg          | 300   | 300  | 300  | 300                | 300                |

#Please note figures are sourced from overseas data where equipment levels by model variant may vary.

\*\*Fuel consumption figures according to Australian Design Rules (ADR) 81/02 derived from laboratory testing. Factors including but not limited to driving style, road and traffic conditions, environmental influences, vehicle condition and accessories fitted, will in practice in the real world lead to figures which generally differ from those advertised. Advertised figures are meant for comparison amongst vehicles only.

#When fitted with Volkswagen Genuine Tow Bar. Towing capacities are applicable to Volkswagen Genuine Accessory Tow Bar. Towing capacity figures are maximum figures and actual towing capacity depends on factors including the laden mass of the vehicle, driving conditions and fitment of any accessories. Volkswagen Group Australia does not endorse or will not be held liable for any claim, loss or damage arising from the use or fitment of electronic trailer brakes.

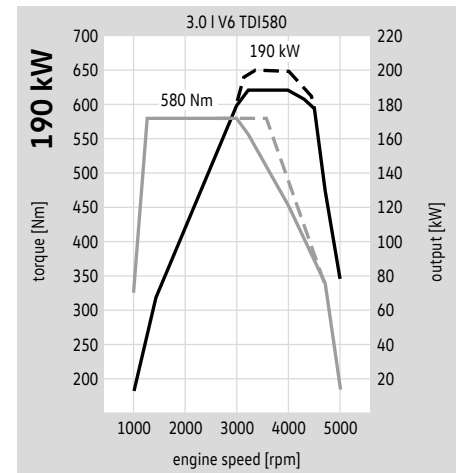
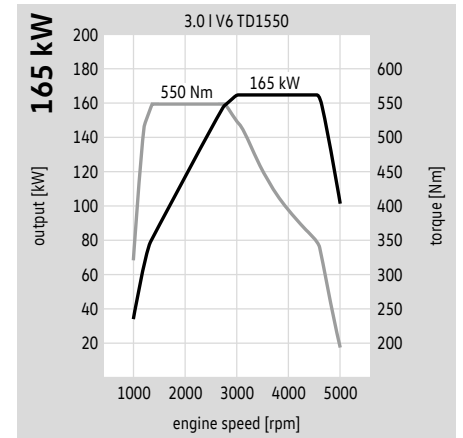
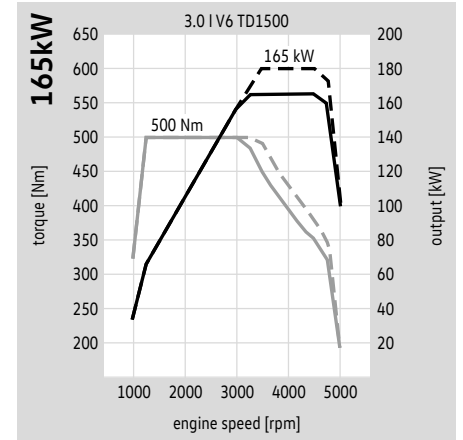

# Technical Specifications - 6 Cylinder Range

| Running Gear                  | 3.0 litre V6 TDI500   | 3.0 litre V6 TDI550   | 3.0 litre V6 TDI580   |             |             |
|-------------------------------|---|---|---|-------------|-------------|
| Suspension                    |   |   |   |             |             |
| Front axle                    | Transverse link with A-frame arm, double wishbone and anti-roll bar                                     | Transverse link with A-frame arm, double wishbone and anti-roll bar                                     | Transverse link with A-frame arm, double wishbone and anti-roll bar                                     |             |             |
| Rear axle                     | Multi-layer rigid axle with leaf spring and stabiliser bar  | Multi-layer rigid axle with leaf spring and stabiliser bar  | Multi-layer rigid axle with leaf spring and stabiliser bar  |             |             |
| Steering                      | Power assisted rack & pinion steering   | Power assisted rack & pinion steering   | Power assisted rack & pinion steering   |             |             |
| Brakes                        |   |   |   |             |             |
| Front / Rear, mm              | Ventilated, 332 / Ventilated, 300   | Ventilated, 332 / Ventilated, 300   | Ventilated, 332 / Ventilated, 300   |             |             |
| Brake systems                 | ESP, ABS, ASR, EDL, Hill Holder, Brake Assist, Traction Control and Off-Road ABS including Hill Descent | ESP, ABS, ASR, EDL, Hill Holder, Brake Assist, Traction Control and Off-Road ABS including Hill Descent | ESP, ABS, ASR, EDL, Hill Holder, Brake Assist, Traction Control and Off-Road ABS including Hill Descent |             |             |
| Turning circle, m             | 12.95   | 12.95   | 12.95   |             |             |
| Weights                       | Core V6 Manual  | Core V6   | Sportline V6  | Highline V6 | Aventura V6 |
| Unladen Mass, kg              | 2,076   | 2,091   | 2,104   | 2,147       | 2,244       |
| Payload, kg †                 | 1,004   | 989   | 976   | 933         | 836         |
| Gross Vehicle Mass (GVM), kg  | 3,080   | 3,080   | 3,080   | 3,080       | 3,080       |
| Gross Combined Mass (GCM), kg | 5,550   | 6,000   | 6,000   | 6,000       | 6,000       |
| Roof load, kg                 | 100   | 100   | 100   | 100         | 100         |

## Dimensions

| Exterior Dimensions     | 3.0 litre V6 TDI500 | 3.0 litre V6 TDI550 | 3.0 litre V6 TDI580 |
|-------------------------|---------------------|---------------------|---------------------|
| Overall length, mm      | 5,254               | 5,254               | 5,254               |
| Width, mm               | 1,954               | 1,954               | 1,954               |
| Width incl. mirrors, mm | 2,228               | 2,228               | 2,228               |
| Height, mm (HL)         | 1,878               | 1,878               | 1,878               |
| Height, mm (UL)         | 1,834               | 1,834               | 1,834               |
| Wheelbase, mm           | 3,095               | 3,095               | 3,095               |
| Ground clearance, mm    | 192                 | 192                 | 192                 |
| Entry angle             | 28.0°               | 28.0°               | 28.0°               |
| Departure angle         | 23.6°               | 23.6°               | 23.6°               |
| Ramp angle              | 23.0°               | 23.0°               | 23.0°               |
| Wading depth, mm        | 500                 | 500                 | 500                 |
| Track Front/Rear, mm    | 1,654 / 1,658       | 1,654 / 1,658       | 1,654 / 1,658       |

| Tray Dimensions                  | 3.0 litre V6 TDI500 | 3.0 litre V6 TDI550 | 3.0 litre V6 TDI580 |
|----------------------------------|---------------------|---------------------|---------------------|
| Length, mm                       | 1,555               | 1,555               | 1,555               |
| Width, mm (Max.)                 | 1,620               | 1,620               | 1,620               |
| Width, mm (between wheel arches) | 1,222               | 1,222               | 1,222               |
| Tailgate opening, mm (Max.)      | 1,364               | 1,364               | 1,364               |
| Height (tailgate,) mm            | 508                 | 508                 | 508                 |
| Height from ground, mm           | 780                 | 780                 | 780                 |

Amarok Dual Cab (with wheel arch flares and rear step bumper)

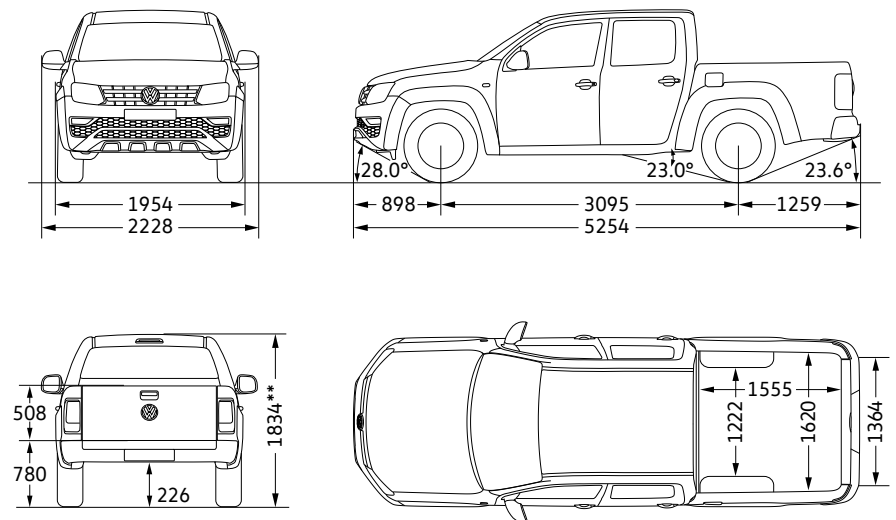

° Track figures are based on rim off-set of 45

† Payload is defined as the Gross Vehicle Mass (GVM) minus the Kerb Mass. Payload is the maximum combined weight of occupants, cargo, added structures and tow ball down weight (when towing). GVM must not be exceeded.

\*\*Height shown without sports bar.

# Volkswagen Accessories

Volkswagen Genuine Accessories ensures your Amarok remains 100% Volkswagen. The extensive range of Amarok Genuine Accessories provides you with the opportunity to adapt your Amarok even more precisely to your individual needs. From interior to exterior solutions, styling options, Volkswagen Genuine Accessories perfectly compliments your Amarok.

For the full range, please visit [www.volkswagen.com.au](http://www.volkswagen.com.au)



**01** 20" Nazare alloy wheel

Part.no 2H6071490NQ9 (Gloss black)



**02** 18" Durban alloy wheel

Part.no 2H6071498Z98 (matte black)



**03** 17" Rocadura alloy wheel

Part.no 2H0071497AFZZ (gloss machined)



**04** Roof bars

Part.no VGA071126AM17 (Flush mount)  
Part.no VGA071126AM17C (Commercial)



**05** Black Side steps with integrated LED lighting

Part.no 2H6071691041  
(wiring harness also required Part no. 2H6071970)



**06** Black Styling bar

Part.no 2H0071000ENP1



**07** Towbar

Part.no 2H6092134  
(3.5 Tonne towbar for Amarok V6 auto only - MY18 onwards)  
Part.no 2H0092134A  
(3.0 Tonne towbar for Amarok with bumper)  
Part.no 2H0092134B  
(3.0 Tonne towbar for Amarok without bumper)



**08** Amarok Platform system

Part.no VGA2H6421AM17



**09** Amarok bonnet protector

Part.no VGA82301M (matte black)  
Part.no VGA823010 (clear)



**10** Slimline weathershields (tinted)

Part.no VGA845015S



**11** Premium Roll Cover

Part.no 2H7071774GNP1  
Part.no 2H7071774ENP1 (Aventura model only)



**12** Amarok Bed Divider system

Part.no VGABDVW80A01



**13** Premium Canopy



**14** Amarok Alloy tray range



**15** Front body underbody styling element  
(black/silver)

Part.no 2H6071003



**16** Amarok self-lowering tailgate system

Part.no VGA2H00ED0800 (with torsion bar)  
Part.no VGA2H00ED0300 (without torsion bar)



**17** Amarok modular tub liner

Part.no VGA2H7061164



**18** Tonneau cover range

Part.no VGA2H7071778  
(to suit without sports bars)  
Part.no VGA2H7071778A  
(to suit with highline sports bars)

## Seat upholstery

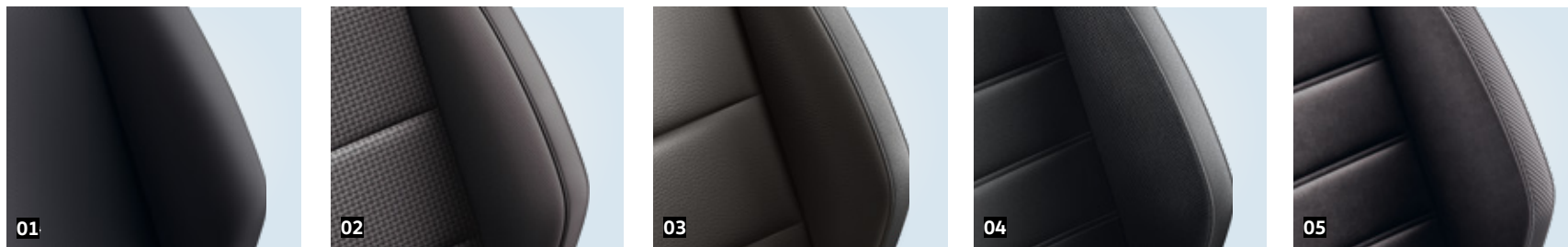

**01** Austin cloth seat upholstery in Titanium Black and Moon Rock Grey | CE | CE6 |

**02** Salipra cloth seat upholstery in Palladium | SL | HL |

**03** Art velour seat upholstery in black | HL |

**04** Vienna leather seat upholstery# in Palladium | HL |

**05** Nappa leather seat upholstery# in Black with seams in Ceramique | AV |

## Wheels



**06** Korama alloy wheel, 6.5 J x 16. With 245/70 R 16 tyres. | CE |

**07** Posadas alloy wheel, 8.0 J x 17. With 245/65 R 17 tyres. | CE6 |

**08** Manaus alloy wheel, 7.5 J x 18. With 255/60 R 18 tyres. | SL |

**09** Rawson alloy wheel 7.5 J x 18 with 255/60 R 18 tyres. | HL |

**10** Talca alloy wheel, 8.0 J x 20. With 255/50 R 20 tyres. | AV |

#Leather appointed seats have a combination of genuine and artificial leather, but are not wholly leather.

## Paint finishes



01



02



03



04



05



06

- 01** Candy White Solid | B4B4 | | CE | CE6 | SL | HL | AV |
- 02** Mojave Beige Metallic | 1B1B | | CE | CE6 | SL | HL |
- 03** Atlantic Blue Metallic | H7H7 | | CE | CE6 | SL | HL | AV |
- 04** Indium Grey Metallic | X3X3 | | CE | CE6 | SL | HL | AV |
- 05** Deep Black Pearl Effect | 2T2T | | CE | CE6 | SL | HL | AV |
- 06** Pyrit Silver Metallic | K2K2 | | CE | CE6 | SL | HL | AV |

#Leather appointed seats have a combination of genuine and artificial leather, but are not wholly leather.

Please note that Metallic and Pearl affect paint are optional at additional cost. The print process does not allow for exact reproduction of the exterior or the upholstery colours. Not all colours are available with optional body coloured bumpers and/or roof height increases.

Please contact your Volkswagen Dealer for further information on colours and upholstery combinations.

# Peace of Mind



## 5 years Unlimited Kilometre Warranty

At Volkswagen, we pride ourselves on the highest quality standards that come with German engineering.

We back this commitment with a 5 year unlimited kilometre warranty on all new Volkswagen vehicles\*.



## 1 year Roadside Assist

Every new Volkswagen comes with a 1 year Roadside Assist membership<sup>^</sup>.

That's 24 hour roadside assistance, emergency accommodation, car rental and towing as well as property and other assistance, all included for added peace of mind.



## Volkswagen Care Plans

Volkswagen Care Plans<sup>†</sup> have you covered for your first 3 or 5 scheduled services, providing you savings off the total Assured Service Pricing RRP. It's convenient, hassle-free scheduled servicing easily available for purchase at your local Volkswagen Dealer.



## Assured Service Pricing

Assured Service Pricing<sup>#</sup> gives you the transparency of knowing how much your service will cost up front.

Our Volkswagen Dealers have access to the latest diagnostic equipment and tools. Plus, they use Volkswagen Genuine Parts<sup>®</sup> to ensure your Volkswagen stays a Volkswagen.

You're in safe hands at your Volkswagen Dealer when it comes to servicing.

\*Conditions and exclusions apply, see <https://www.volkswagen.com.au/en/owners-service/warranty.html>. Your rights under this warranty are provided in addition to, and in some cases overlap with, consumer guarantees under the Australian Consumer Law and do not limit or replace them.

<sup>^</sup>Volkswagen Roadside Assist is provided by AWP Australia Pty Ltd ABN 52 097 227 177 trading as Allianz Global Assistance, under an arrangement with Volkswagen Group Australia Pty Limited ABN 14 093 117 876. Conditions and exclusions apply, see <https://www.volkswagen.com.au/en/owners-service/roadside-assist.html>.

<sup>†</sup>Volkswagen Care Plans are available at participating Volkswagen Dealers for all models and covers standard items as contained in each scheduled service interval only. These Care Plans can only be purchased prior to the first scheduled service and up to 22,500 km/15 months (whichever occurs first) for all models except Volkswagen Crafter models, which is 30,000 km/15 months (whichever occurs first). The time frame takes effect from when the vehicle is first reported in our system as 'sold'. Discount structure varies by model. For details of what is not included in a scheduled service, see <https://www.volkswagen.com.au/en/owners-service/care-plans.html>.

<sup>#</sup>Assured Service Pricing applies to the first 5 standard scheduled services of your vehicle which are scheduled to occur at every 15,000 km/12 month interval (whichever occurs first) or for Volkswagen Crafter models only, 20,000 km/12 month interval (whichever occurs first). On or before 31 December each year, Volkswagen will publish the maximum price for a specified Scheduled Service that will be applicable from, and remain fixed for, the following calendar year only. For details on the Eligible Model List, pricing, items not included and for full terms and conditions, please see <https://www.volkswagen.com.au/app/locals/service-pricing-guide>.



# Volkswagen Choice

Guaranteed Future Value

Naturally we understand that your Volkswagen represents a valuable investment, so we understand that you want to maintain it in premium condition. Volkswagen Choice<sup>^</sup> is a finance program tailored to the requirements of Volkswagen owners by providing assurance around your Volkswagen's future value<sup>^</sup>, whilst offering simple monthly instalment financing options.

Whether you are selecting your new Volkswagen for business or personal use, you can choose the contract term that best suits your requirements. Enjoy the confidence that comes from having locked in a minimum value up front to be attributed to your vehicle at the end of your contract<sup>^</sup>. There are also no account keeping fees with a fixed interest rate.

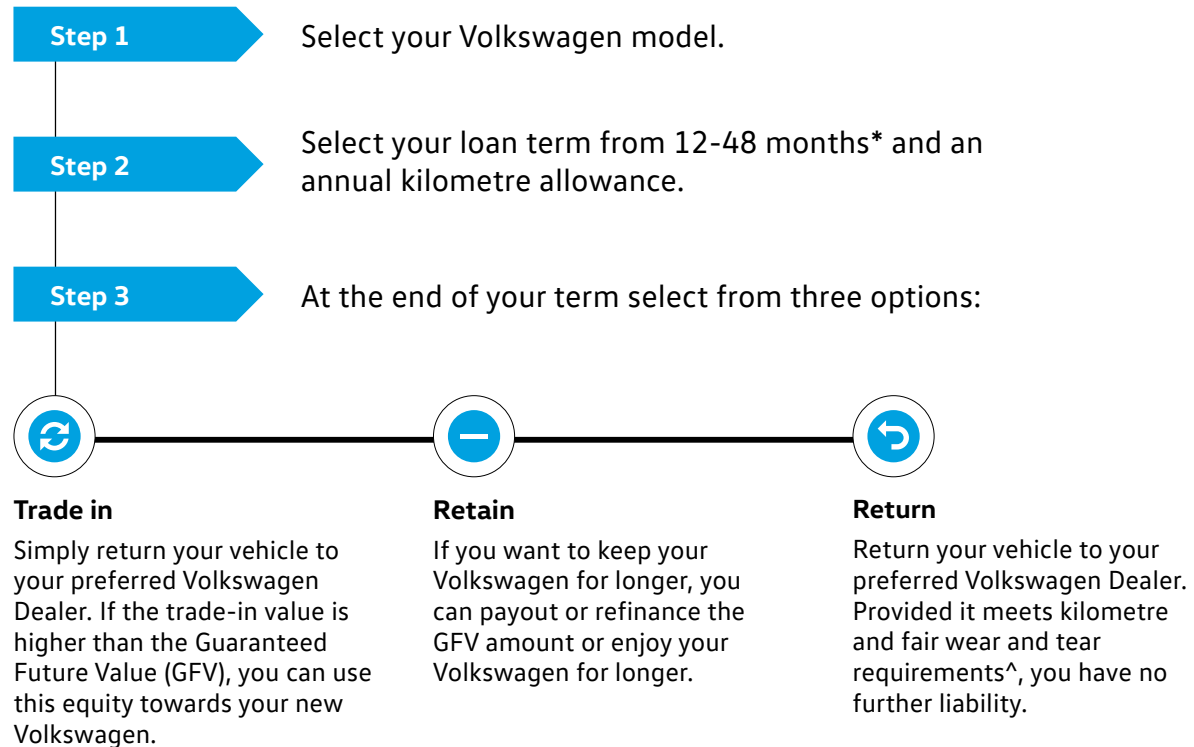

\*GFV terms offered subject to change.

<sup>^</sup>Volkswagen Guaranteed Future Value consists of an option to return your vehicle to Volkswagen Financial Services (VFS) ABN 20 097 071 460, Australian Credit Licence 389344, at the end of the term and requires VFS to purchase the vehicle at an agreed price determined by VFS, known as the Guaranteed Future Value (GFV). At the end of the term, you can elect to: (1) trade-in; (2) return; or (3) retain the vehicle by paying the GFV, which is a lump sum owed to VFS at the end of the loan term after all repayments have been made. You will be liable for any loan contract deficit and additional charges if you exceed the nominated kilometre allowance and/or the vehicle is not in an acceptable condition. Available on new and demonstrator Volkswagen vehicles for selected models. Contact your Official Volkswagen Dealer to verify eligible vehicles for this program. Fleet, government, rental buyers, hire car and chauffeur companies excluded.

# The Amarok

Volkswagen Group Australia Pty Ltd  
24 Muir Road Chullora NSW 2190  
ABN 14 093 117 876

Printed in Australia  
November 2020  
[www.volkswagen.com.au](http://www.volkswagen.com.au)

Publication: VWCAMARMY21

Your Volkswagen Dealer.

#### **Important information**

Apple CarPlay® is a registered trade mark of Apple Inc. Android Auto™ is a registered trade mark of Google Inc. MirrorLink® is a registered trade mark of Car Connectivity Consortium LLC. Bluetooth® is a registered trade mark of Bluetooth SIG Inc.

Volkswagen distributed by Volkswagen Group Australia Pty Ltd (ABN 14 093 117 876) of 24 Muir Road Chullora, NSW 2190. Specifications are as planned at November 2020, for Model Year 2021 and are subject to change without notice or obligation. All information in this brochure are correct at the time of publication, however variations may occur from time to time and Volkswagen, in so far as it is permitted by law to do so, shall not be liable in any way as a result of any reliance by any person on anything contained in this brochure. Authorised Volkswagen Dealers will provide up-to-date information on model application, design feature, prices, and availability on request.



Commercial  
Vehicles

# The Amarok Specifications



# Features and Specifications

## Safety and Security

### Airbags

Driver and front passenger airbags

Driver and front passenger side (head & thorax) airbags

### Seat Belts

3 point seat belts for all passengers

Front height adjustable seat belts with pre-tensioners and belt force limiters

Outer rear seat belt pre-tensioners

Visual and acoustic warning for driver and front passenger seat belt not fastened

### Child Restraints

Child seat top tether anchorage points (3)

ISOFIX child seat anchorage points, outer rear seats

### Brakes and Traction Control

Automatic flashing brake lights activated in emergency braking situation

Electronic Stability Programme (ESP)

Electronic Brake-pressure Distribution (EBD)

Anti-lock Braking System (ABS)

Brake Assist

Anti-Slip Regulation (ASR)

Electronic Differential Lock (EDL)

Auto Hold function

Trailer Sway Stability Control (only with genuine tow bar wiring kit)

Mechanical Differential Lock

Multi-collision brake

Active Roll-over Prevention

### Driver Assistance Technology\*

Off-road mode with optimised ABS, ESP, transmission and hill descent control

Parking distance sensors, rear with acoustic warning

Optical Parking System (OPS) in audio display

Rear View Camera (RVC) with static guidance lines

Dusk sensing headlight function

Rain sensing wipers

## Amarok Dual Cab

### Core 4x4

●

●

●

●

●

●

●

●

●

●

●

●

●

●

●

●

●

●

●

●

●

●

●

●

○

○

\*Safety technologies are designed to assist the driver, but should not be used as a substitute for safe driving practices.

● Standard   ○ Optional Extra   — Not available   A Volkswagen Genuine Accessory (Dealer fitted)

---

## Safety and Security

## Amarok Dual Cab Core 4x4

### Lighting

---

Halogen headlamps

---

●

---

Front fog lights

---

○

---

Coming / leaving home function

---

○

---

Internal headlight range adjustment

---

●

---

Rear high mount stop light, LED

---

●

---

Rear fog lamp

---

●

### Locking

---

Electronic engine immobiliser

---

●

---

Remote central locking with folding key (3)

---

●

---

Lockable glovebox

---

●

### Head Restraints

---

Rear head restraints height adjustable (3)

---

●

---

## Exterior Equipment / Styling

### Roof

---

Roof gutter inserts (Black)

---

●

---

Roof bar mounting points

---

●

---

Roof bars

---

A

---

Bicycle, kayak, ski, surfboard and snowboard holders

---

A

### Towbar

---

Towbar with removable tongue

---

A

---

Wiring Kit - 7-pin flat trailer connector

---

A

### Windows

---

Power front / rear, with roll-back function and one touch up-down

---

●

---

Remote operated convenience close and open feature

---

●

---

Heat insulating tinted glass

---

●

## Exterior Equipment / Styling

## Amarok Dual Cab Core 4x4

### Body Enhancements

|   |   |
|---|---|
| Body coloured front bumper bar                | ● |
| Matte black rear step bumper                  | ● |
| Styling Bar (Matte Black) - Standard type     | A |
| Side Steps (Matte Black)                      | A |
| Side Steps (Stainless Steel)                  | A |
| Styling Bar (Stainless Steel) - Standard type | A |
| Rolling cover (lockable)                      | A |
| Hard tonneau cover (lockable)                 | A |
| Soft tonneau cover                            | A |
| Canopy with side windows and rear door        | A |

### Protection

|   |   |
|---|---|
| Underbody protection (Engine) - Plate type  | ● |
| Underbody protection (Engine) - Bar type    | A |
| Mudflaps - front and rear                   | ● |
| Slimline weather shields (set of 4)         | A |
| Slimline bonnet protector - clear or tinted | A |
| Tubliner - Under rail plastic               | A |
| Underbody protection (Fuel tank)            | A |

### Wheels and Tyres

|   |   |
|---|---|
| Alloy wheels (Korama) 16 x 6.5" with 245/70 R16 | ● |
| Full size steel spare wheel                     | ● |

## Comfort & Convenience

## Amarok Dual Cab Core 4x4

### Air Conditioning

Single zone air-conditioning



### Cruise Control

Cruise Control with stork mounted controls



### In-Car Entertainment and Technology

#### Composition Media audio system 6.33"

6.33" colour touch screen display, AM/FM radio with phase diversity tuner, CD player (MP3/WMA compatible), AUX and SD card slot and external USB input. Car menu with convenience and service settings. Includes display for park distance control (if fitted).



App-Connect™ USB interface for Apple CarPlay®, Android Auto™ and MirrorLink® in centre console



Audio, Telephone and Multi-Function Display controls mounted on steering wheel



Auxiliary input audio socket in centre console



Bluetooth® phone connectivity with contacts display, operation via touch screen audio unit or Multi-Function Display and Bluetooth® audio streaming



Speakers - front and rear (6)



Voice operation, telephone system functions can be operated using voice commands



### Instrumentation

Speedometer & tachometer, electronic odometer and tripmeter, digital clock, fuel and coolant gauges, ambient temperature display, transmission gear indicator



Multi-Function Display (MFD Plus) monochrome display – driving time, trip length, average and current speed, average and current fuel consumption, distance till empty, speed warning function, vehicle status, audio, telephone, navigation and convenience menus



### 12 V Socket

Centre console



### Interior Lighting

Interior lights - door operated



Reading lights - rear



## Comfort & Convenience

## Amarok Dual Cab Core 4x4

| <b>Interior Trims</b>                                  |   |
|--|---|
| Shadow chrome-look decorative dashboard insert         | ● |
| Leather covered steering wheel and gearshift knob      | ● |
| Rubber floor covering in cab                           | ● |
| Carpet mats - front and rear with decorative stitching | A |
| Rubber mats - front and rear                           | A |
| <b>Mirrors</b>   |   |
| Electric adjusted door mirrors with heating function   | ● |
| <b>Steering Wheel</b>                                  |   |
| 3 spoke leather covered steering wheel                 | ● |
| Audio, Telephone and Multi-Function Display controls   | ● |
| Height and reach adjustable steering wheel             | ● |
| <b>Seating</b>   |   |
| Cloth seat upholstery - Austin trim                    | ● |
| Manual height adjustment - front                       | ● |
| Lumbar support - front                                 | ○ |
| Rear seat backrest forward folding                     | ● |
| Rear seat base split folding (60/40)                   | ● |
| <b>Grab Handles</b>                                    |   |
| Roof line folding grab handles (4)                     | ● |
| A-pillar fixed grab handle (1)                         | ● |



## Comfort & Convenience

## Amarok Dual Cab Core 4x4

### Storage

Centre console armrest with storage compartment

●

Door pockets - front and rear

●

Driver's and passenger's side vanity mirrors

●

Compartment with lid in roof console

●

Bottle holders in front and rear door pockets

●

### Tray Body

Lashing rings for load restraining (4)

●

Cargo area light

●

### Mechanical

Mechanical Differential Lock

●

6-speed Manual Transmission

●

8-speed Automatic Transmission

○

Selectable 4MOTION Transmission (Standard with Manual)

●

Permanent 4MOTION Transmission (Standard with Auto)

○

## Optional Equipments

### Options

Front fog lamps

○

Alloy wheels (Korama) 16 x 6.5" with 245/70 R16

●

### Paint

Metallic or Pearl Effect paint finish

○

### Option Packs

Drivers pack - Front lumbar support, automatic headlights, rain sensing wipers and additional 12v socket

○

# Technical Specifications

| Engine                          | TDI400 4x4  | TDI420 4x4               |
|---------------------------------|---|--------------------------|
| Type                            | 4 cylinder Bi-turbo diesel, DOHC, 16 valve  |                          |
| Cubic capacity, litres/cc       | 2.0 / 1,968   |                          |
| Max power, kW @ rpm             | 132 @ 4,000   | 132 @ 4,000              |
| Max torque, Nm @ rpm            | 400 @ 1,500 - 2,250   | 420 @ 1,750              |
| Compression ratio               | 16.01:1   |                          |
| Fuel system                     | Common Rail Direct Injection  |                          |
| Exhaust emission control        | Water-cooled exhaust gas recirculation (EGR), catalytic converter and diesel particulate filter (DPF) |                          |
| Fuel type (Recommended)         | Diesel EN 590   |                          |
| <b>Transmission</b>             | <b>6 Speed Manual</b>   | <b>8 Speed Automatic</b> |
| Driven wheels                   | 4x4 (4MOTION) Selectable  | 4x4 (4MOTION) Permanent  |
| Gear Ratios                     | Final Drive: 4.10   | Final Drive: 3.70        |
|                                 | 1st Gear: 3.583   | 1st Gear: 4.714          |
|                                 | 2nd Gear: 1.889   | 2nd Gear: 3.143          |
|                                 | 3rd Gear: 1.114   | 3rd Gear: 2.106          |
|                                 | 4th Gear: 1.00  | 4th Gear: 1.667          |
|                                 | 5th Gear: 0.564   | 5th Gear: 1.285          |
|                                 | 6th Gear: 0.473   | 6th Gear: 1.00           |
|                                 |   | 7th Gear: 0.839          |
|                                 |   | 8th Gear: 0.667          |
|                                 | Reverse Gear: 3.250   | Reverse Gear: 3.300      |
| <b>Fuel Consumption**</b>       |   |                          |
| Combined, L/100km               | 8.4   | 8.9                      |
| Urban, L/100km                  | 10.1  | 11                       |
| Extra Urban, L/100km            | 7.4   | 7.7                      |
| CO <sub>2</sub> emissions, g/km | 220   | 234                      |
| Fuel tank capacity, litres      | 80  |                          |
| <b>Towbar Capacity*</b>         |   |                          |
| Braked kg                       | 3,000   |                          |
| Unbraked, kg                    | 750   |                          |
| Towball load limit, kg          | 300   |                          |

\*\*Fuel consumption figures according to Australian Design Rule (ADR) 81/02 derived from laboratory testing. Factors including but not limited to driving style, road and traffic conditions, environmental influences, vehicle condition and accessories fitted, will in practice in the real world lead to figures which generally differ from those advertised. Advertised figures are meant for comparison amongst vehicles only.

\*When fitted with Volkswagen Genuine Tow Bar. Towing capacities are applicable to Volkswagen Genuine Accessory Tow Bar. Towing capacity figures are maximum figures and actual towing capacity depends on factors including the laden mass of the vehicle, driving conditions and fitment of any accessories. Volkswagen Group Australia does not endorse or will not be held liable for any claim, loss or damage arising from the use or fitment of electronic trailer brakes.

# Technical Specification

## Chassis

Full-length ladder frame chassis in high strength steel  
Fully galvanised body with 6 year anti-corrosion perforation warranty

## Running Gear

2.0 litre, 4 cylinder TDI

## Suspension

Front axle  
Rear axle

Transverse link with A-frame arm double wishbone and anti-roll bar  
Multi-layer rigid axle with leaf spring and stabiliser bar

## Steering

Power assisted rack & pinion steering

## Brake systems

Front, mm  
Rear, mm

303, Ventilated Discs  
295, Drum

## Brake systems

ESP, off-road ABS, ASR, EDL, Hill Holder, Brake Assist, Traction Control and Off-Road ABS including Hill Descent

## Turning circle, metres

12.95

# Measurements and Dimensions

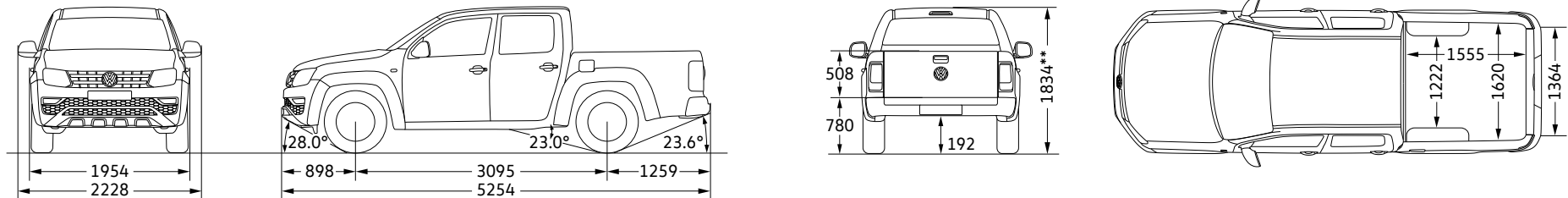

\*\*Maximum height excludes styling bar fitment

# Measurements and Dimensions

| Weights <sup>#</sup>                   | TDI400 4x4 | TDI420 4x4 |
|--|------------|------------|
| Unladen Mass Kg`s - Core               | 2,007      | 2,007      |
| Payload <sup>†</sup> kg - Core         | 1,033      | 1,033      |
| Gross Vehicle Mass (GVM) kg            | 3,040      | 3,040      |
| Gross Combined Mass (GCM) kg           | 5,550      | 5,550      |
| Roof load, kg                          | 100        | 100        |
| <b>Exterior Dimensions<sup>#</sup></b> |            |            |
| Overall length mm                      | 5,254      | 5,254      |
| Width mm                               | 1,954      | 1,954      |
| Width incl. mirrors mm                 | 2,228      | 2,228      |
| Height, mm                             | 1,834      | 1,834      |
| Wheelbase mm                           | 3,095      | 3,095      |
| Ground clearance, mm                   | 226        | 226        |
| Entry angle                            | 28°        | 28°        |
| Departure angle                        | 23.6°      | 23.6°      |
| Ramp angle                             | 23.0°      | 23.0°      |
| Wading depth, mm                       | 500        | 500        |
| <b>Tray Dimensions<sup>#</sup></b>     |            |            |
| Length, mm                             | 1,555      |            |
| Width mm (Max.)                        | 1,620      |            |
| Width mm (between wheel arches)        | 1,222      |            |
| Tail gate opening mm (Max.)            | 1,364      |            |
| Height (tail gate) mm                  | 508        |            |
| load area m                            | 2.52t      |            |
| Height from ground mm                  | 780        |            |

<sup>#</sup> Please note figures are sourced from overseas data where equipment levels by model variant may vary.

<sup>†</sup> Payload is defined as the Gross Vehicle Mass (GVM) minus the Kerb Mass. Payload is defined as the Gross Vehicle Mass (GVM) minus the Kerb Mass. Payload is the maximum combined weight of occupants, cargo, added structures and tow ball down weight (when towing). GVM must not be exceeded

# Colours and Upholstery

---

## Solid paint finishes



**Candy White** | Solid paint finish | B4B4

## Metallic and Pearlescent paint finishes



**Mojave Beige** | Metallic paint finish | 1B1B



**Indium Grey** | Metallic paint finish | X3X3



**Pyrit Silver** | Metallic paint finish | 8E8E



**Atlantic Blue** | Metallic paint finish | H7H7



**Deep Black** | Pearl paint finish | 2T2T

## Seat upholstery



**Austin**  
Cloth seat upholstery | Titanium Black and Moon Rock Grey

# The Amarok

Volkswagen Group Australia Pty Ltd  
24 Muir Road Chullora NSW 2190  
ABN 14 093 117 876

Printed in Australia  
October 2020  
[www.volkswagen.com.au](http://www.volkswagen.com.au)

Publication: VWCAMA4CYLMY21

Your Volkswagen Dealer.

#### **Important information**

Apple CarPlay® is a registered trade mark of Apple Inc. Android Auto™ is a registered trade mark of Google Inc. MirrorLink® is a registered trade mark of Car Connectivity Consortium LLC. Bluetooth® is a registered trade mark of Bluetooth SIG Inc.

Volkswagen is distributed by Volkswagen Group Australia Pty Ltd (ABN 14 093 117 876) of 24 Muir Road Chullora, NSW 2190. Specifications are as planned at October 2020, for Model Year 2021 and are subject to change without notice or obligation. All information in this brochure are correct at the time of publication, however variations may occur from time to time and Volkswagen, in so far as it is permitted by law to do so, shall not be liable in any way as a result of any reliance by any person on anything contained in this brochure. Authorised Volkswagen Dealers will provide up-to-date information on model application, design feature, prices, and availability on request.